

Emergency Stop Switch

# A22E

## Install in 22-dia. or 25-dia. Panel Cutout

- Direct opening mechanism with minimum contact separation of 3 mm in accordance with EN60947-5-1, ⊖. (only for NC contacts)
- Safety lock mechanism prevents misuse. (No tampering – in accordance with EN 418)
- Easy mounting and removal of Switch Blocks using an incorporated lever.
- Finger protection mechanism on Switch Unit provided as a standard feature.
- Install using either round, forked crimp terminals, or ferrules.



### For additional installation of emergency-stop switches.



A22Z-3466-1



A22E-□-□

Emergency-stop switches can be installed easily far from machines.



A22Z-B101Y  
Control Box

## Model Number Structure

### Model Number Legend

#### Completely Assembled

Shipped as a set which includes the Pushbutton, Lamp (lighted models only), and Switch.

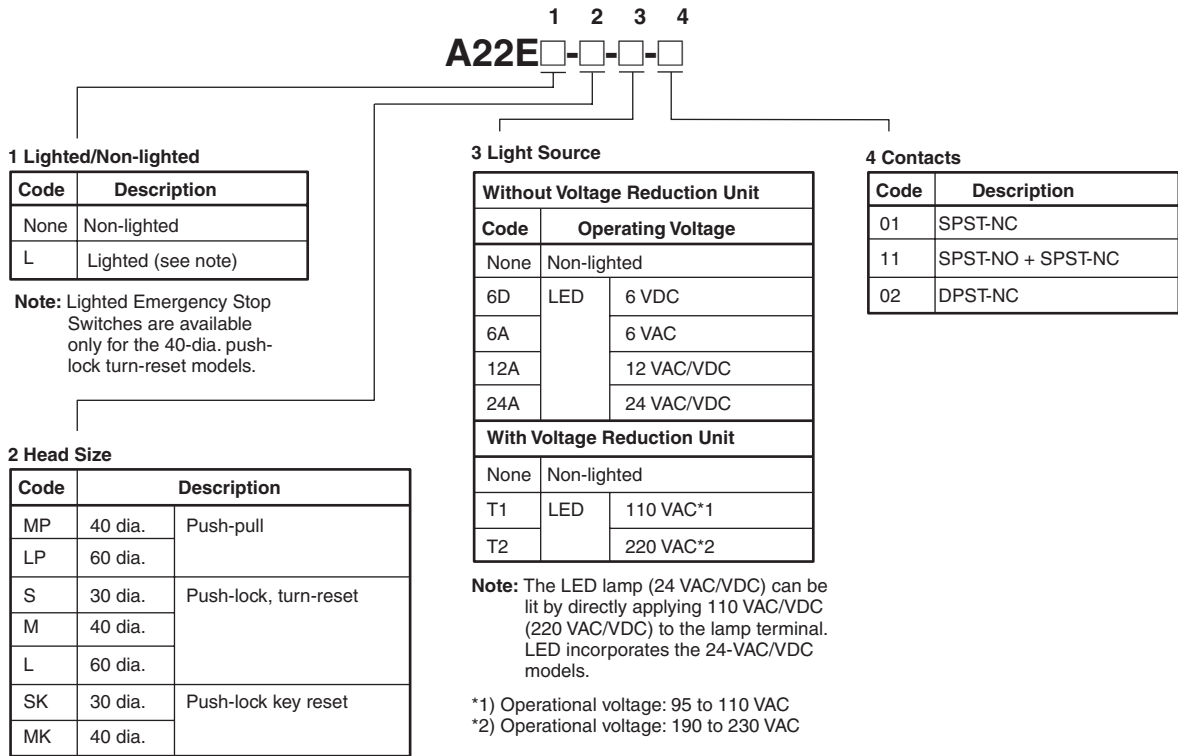

### Subassembled

The Pushbutton, Lamp, or Switch can be ordered separately. Use them in combination for models that are not available as assembled Units. These can also be used as inventory for maintenance parts.

### Unit Combinations

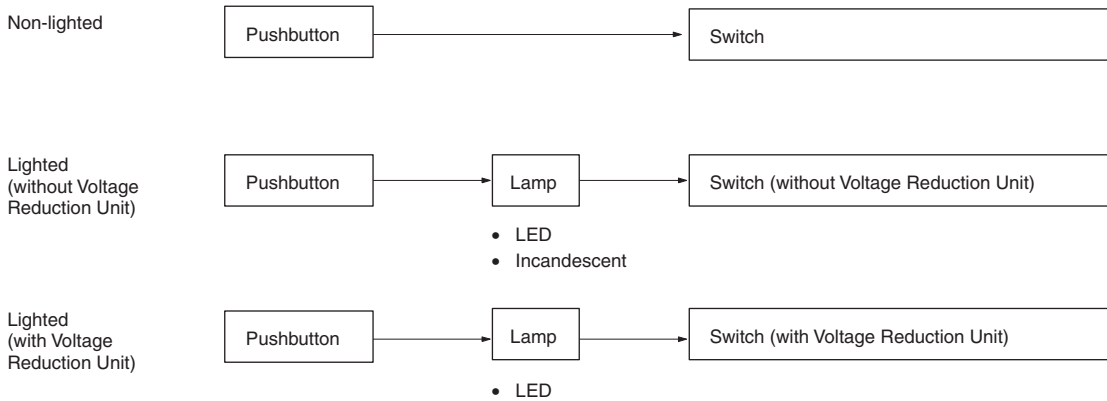

### 1. Pushbutton

Lighted/Non-lighted

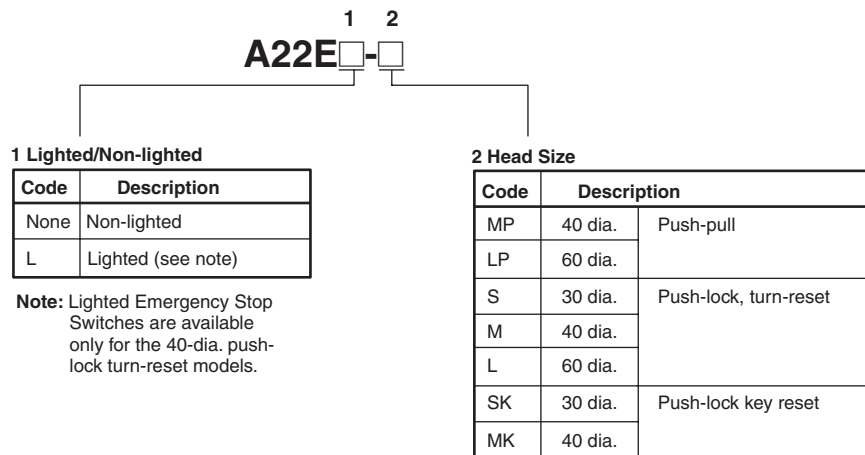

### 2. Lamp

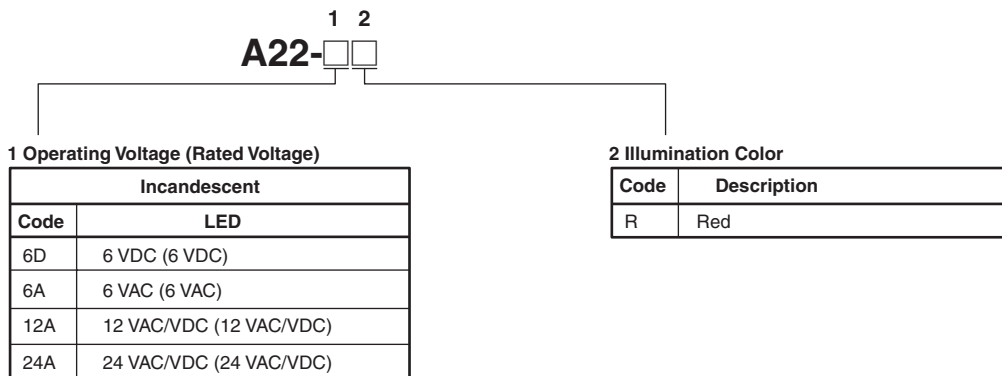

### 3. Switch

Lighted/Non-lighted

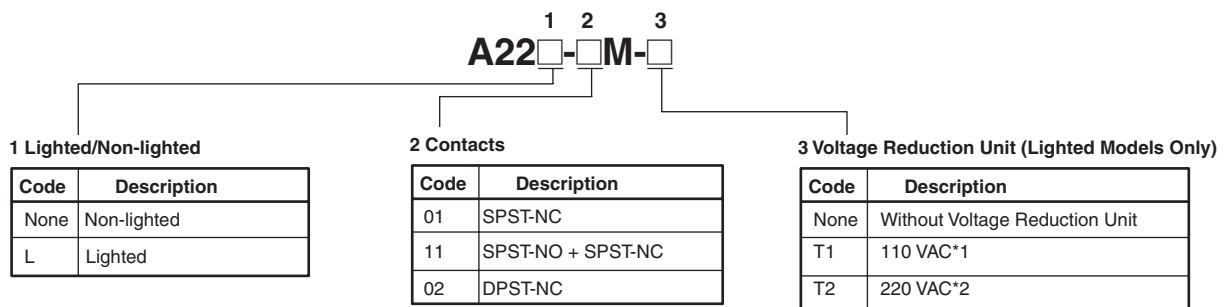







\*1) Operational voltage: 95 to 110 VAC  
\*2) Operational voltage: 190 to 230 VAC

## Ordering Information

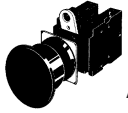

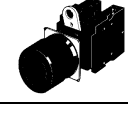
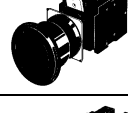
### List of Models

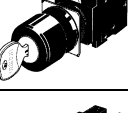
Completely Assembled (Ask your local OMRON representative)

#### Non-lighted Models

Appearance	Output	Push-lock turn-reset system	Color of cap
40-dia. head Push-pull  A22E-MP	SPST-NC	A22E-MP-01	Red
	SPST-NO/SPST-NC	A22E-MP-11	
	DPST-NC	A22E-MP-02	
60-dia. head Push-pull  A22E-LP	SPST-NC	A22E-LP-01	
	SPST-NO/SPST-NC	A22E-LP-11	
	DPST-NC	A22E-LP-02	
30-dia. head Push-lock Turn-reset  A22E-S	SPST-NC	A22E-S-01	
	SPST-NO/SPST-NC	A22E-S-11	
	DPST-NC	A22E-S-02	
40-dia. head Push-lock Turn-reset  A22E-M	SPST-NC	A22E-M-01	
	SPST-NO/SPST-NC	A22E-M-11	
	DPST-NC	A22E-M-02	
60-dia. head Push-lock Turn-reset  A22E-L	SPST-NC	A22E-L-01	
	SPST-NO/SPST-NC	A22E-L-11	
	DPST-NC	A22E-L-02	
30-dia. head Push-lock Key-reset  A22E-SK	SPST-NC	A22E-SK-01	
	SPST-NO/SPST-NC	A22E-SK-11	
	DPST-NC	A22E-SK-02	
40-dia. head Push-lock Key-reset  A22E-MK	SPST-NC	A22E-MK-01	
	SPST-NO/SPST-NC	A22E-MK-11	
	DPST-NC	A22E-MK-02	

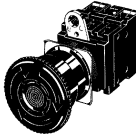





#### Lighted Models

Appearance	Output	Lighting	Rated voltage	Push-lock turn-reset system	Color of cap
40-dia. head Push-lock Turn-reset 	SPST-NC	LED	6 VDC	A22EL-M-6D-01	Red
			6 VAC	A22EL-M-6A-01	
			12 VAC/VDC	A22EL-M-12A-01	
	SPST-NO/SPST-NC		24 VAC/VDC	A22EL-M-24A-01	
			6 VDC	A22EL-M-6D-11	
			6 VAC	A22EL-M-6A-11	
	DPST-NC		12 VAC/VDC	A22EL-M-12A-11	
			24 VAC/VDC	A22EL-M-24A-11	
			6 VDC	A22EL-M-6D-02	
			6 VAC	A22EL-M-6A-02	
			12 VAC/VDC	A22EL-M-12A-02	
			24 VAC/VDC	A22EL-M-24A-02	
40-dia. head Push-lock Turn-reset with Voltage Reduction Unit 	SPST-NC	110 VAC	A22EL-M-T1-01		
		220 VAC	A22EL-M-T2-01		
	SPST-NO/SPST-NC	110 VAC	A22EL-M-T1-11		
		220 VAC	A22EL-M-T2-11		
	DPST-NC	110 VAC	A22EL-M-T1-02		
		220 VAC	A22EL-M-T2-02		

Subassembled

Pushbuttons

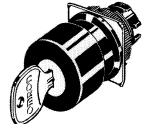
Non-lighted

Sealing capability and size	IP65 oil-resistant models		
	Small (30 dia.)	Medium (40 dia.)	Large (60 dia.)
Push-pull	---	A22E-MP 	A22E-LP 
Push-lock, Turn-reset	A22E-S 	A22E-M 	A22E-L 
Push-lock, key-reset	A22E-SK 	A22E-MK 	---

Lighted

Sealing capability and size	IP65
	Medium (40 dia.)
Push-lock, Turn-reset	A22EL-M 

Lamp

LED

Rated voltage	6 VDC	6 VAC	12 VAC/VDC	24 VAC/VDC	Super-bright 24 VAC/VDC
 LED light					
Red	A22-6DR	A22-6AR	A22-12AR	A22-24AR	A22-24ASR

**Note:** For voltage-reduction lighting, use the A22-24AR.

Incandescent

Rated voltage	6 VAC	14 VAC	28 VAC	130 VAC
	A22-5	A22-12	A22-24	A22-H1

Switch (Standard Load)  
Without Voltage Reduction Unit

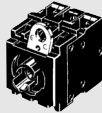



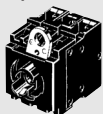
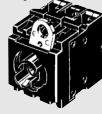



Classification		Non-lighted	Lighted
Appearance			
Switch Action		Momentary	Momentary
Contacts			
For standard loads	SPST-NO	A22-10M	A22L-10M
	SPST-NC	A22-01M	A22L-01M
	SPST-NO + SPST-NC	A22-11M	A22L-11M
	DPST-NO	A22-20M	A22L-20M
	DPST-NC	A22-02M	A22L-02M

With Voltage Reduction Unit

Classification		Lighted (110 VAC)	Lighted (220 VAC)
Appearance			
Switch Action		Momentary	Momentary
Contacts			
For standard loads	SPST-NO	A22L-10M-T1	A22L-10M-T2
	SPST-NC	A22L-01M-T1	A22L-01M-T2
	SPST-NO + SPST-NC	A22L-11M-T1	A22L-11M-T2
	DPST-NO	A22L-20M-T1	A22L-20M-T2
	DPST-NC	A22L-02M-T1	A22L-02M-T2

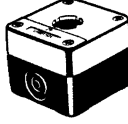
- Note:** 1. The above illustrations are for the DPST-NO contact.  
2. When using with a Voltage Reduction Unit, use the A22-24AR.

Accessories (Order Separately)

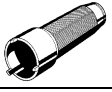
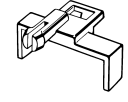
Item	Appearance	Classification	Model	Remarks	
Switch Blocks		SPST-NO	A22-10	Provided as standard. Order Switch Blocks only when adding or replacing them.	
		SPST-NC	A22-01		
Lamp Sockets		Direct lighting	A22-TN	Used when changing the lighting method.	
		Voltage-reduction lighting	110 VAC		A22-T1
			220 VAC		A22-T2
Mounting Latches		For momentary-action models	A22-3200	Provided as standard. Order Mounting Latches only when mounting Switch Blocks or Lamp Sockets that are purchased individually.	
		For alternate-action models	A22-3210		
Lock Ring		Rounded shape	A22Z-3360	The body is equipped with a Lock Fitting. This Lock Fitting is used when a more secure lock feature is required.	
Hole Plug		Round	A22Z-3530	Can be plugged into pre-cut panel holes for future expansion. The color is black.	
Control Boxes (Enclosures)		One hole	A22Z-B101	Material: Polycarbonate resin	
		One hole, yellow box (for emergency stop)	A22Z-B101Y		
		Two holes	A22Z-B102		
		Three holes	A22Z-B103		
Connectors		Applicable cable diameter (mm)	7 to 9 dia.	A22Z-3500-1	Plastic connector used to extend a cable from the Switch Box.
			9 to 11 dia.	A22Z-3500-2	
25-dia. Ring		—	A22Z-R25	Can be fit into a 25-dia. hole in the panel. Since this is not attached to the main body, order separately.	
Legend Plates for Emergency Stop		60-dia. black letters on yellow back-ground	A22Z-3466-1	"EMERGENCY STOP" is indicated on the plate.	
		90-dia. black letters on yellow back-ground	A22Z-3476-1		
Lamp Extractor		—	A22Z-3901	Rubber tool used to replace Lamps easily	
Tightening Tool		—	A22Z-3905	Tool used to tighten nuts from the back of the panel	
Lock Plate		---	A22Z-3380	Use to fix the lever on the Switch.	

## Specifications

### Approved Standards

Recognized organization	Standards	File No.
UL (See note.)	UL508	E41515
AZCO	EN60947-5-1	C9805502

**Note:** UL-approved for CSA C22.2 No. 14 and bears the cUL mark.

### Approved Standard Ratings

- UL, cUL (File No. E41515)  
6 A at 220 V, 10 A at 110 VAC
- EN60947-5-1 (Low Voltage Directive)  
Rated current: 10 A; Rated voltage: 220 VAC

### Ratings

#### Contacts (Standard Load)

Rated carry current	Rated voltage	Rated current (A)			
		AC15 (inductive load)	AC12 (resistive load)	DC13 (inductive load)	DC12 (resistive load)
10	24 VAC	10	10	---	---
	110 VAC	5	10		
	220 VAC	3	6		
	380 VAC	2	3		
	440 VAC	1	2		
	24 VDC	---	---	1.5	10
	110 VDC			0.5	2
	220 VDC			0.2	0.6
	380 VDC			0.1	0.2

**Note: 1.** Rated current values are determined according to the testing conditions. The above ratings were obtained by conducting tests under the following conditions.

- (1) Ambient temperature:  $20 \pm 2^\circ\text{C}$
- (2) Ambient humidity:  $65 \pm 5\%$
- (3) Operating frequency: 20 operations/minute

**2.** Minimum applicable load: 10 mA at 5 VDC

#### Contacts (Microload)

Rated applicable load	Minimum applicable load
50 mA at 5 VDC (Resistive load)	1 mA at 5 VDC

#### LED Indicators without Voltage Reduction Unit

Rated voltage	Rated current	Operating voltage
6 VDC	60 mA	6 VDC $\pm 5\%$
6 VAC	60 mA	6 VAC/VDC $\pm 5\%$
12 VAC/VDC	30 mA	12 VAC/VDC $\pm 5\%$
24 VAC/VDC	15 mA	24 VAC/VDC $\pm 5\%$

#### Super-bright LED Indicator

Rated voltage	Rated current	Operating voltage
24 VAC/VDC	15 mA	24 VAC/VDC $\pm 5\%$

#### Incandescent Lamp

Rated voltage	Rated current	Operating voltage
6 VAC/VDC	200 mA	5 VAC/VDC
14 VAC/VDC	80 mA	12 VAC/VDC
28 VAC/VDC	40 mA	24 VAC/VDC
130 VAC/VDC	20 mA	100 VAC/VDC

#### Voltage-reduction Lighting

Rated voltage	Operational voltage	Applicable lamp (BA9S/13□ gold)
110 VAC	95 to 115 VAC	LED Lamp
220 VAC	190 to 230 VAC	(A22-24A□)



## Characteristics

Item		Emergency Stop Switches	
		Non-lighted model: A22E	Lighted model: A22EL
Allowable operating frequency	Mechanical	30 operations/minute max.	
	Electrical	30 operations/minute max.	
Insulation resistance		100 MΩ min. (at 500 VDC)	
Dielectric strength		2,500 VAC, 50/60 Hz for 1 min between terminals of same polarity 2,500 VAC, 50/60 Hz for 1 min between terminals of different polarity and also between each terminal and ground	
Vibration resistance		Malfunction (See note 2.): 10 to 55 Hz, 1.5-mm double amplitude	
Shock resistance	Mechanical	1,000 m/s <sup>2</sup>	
	Malfunction (See note 2.)	250 m/s <sup>2</sup> max.	
Durability	Mechanical	Momentary operation: 300,000 operations min.	
	Electrical	300,000 operations min.	
Ambient temperature (See note 1.)		Operating: -20°C to 70°C Storage: -40°C to 70°C	Operating: -20°C to 55°C Storage: -40°C to 70°C
Ambient humidity		Operating: 35% to 85%	
Degree of protection		IP65 (oil-resistant)	IP65
Electric shock protection class		Class II	
PTI (tracking characteristic)		175	
Degree of contamination		3 (IEC947-5-1)	

- Note:** 1. With no icing or condensation.  
2. Malfunction within 1 ms.

## Operating Characteristics (for SPST-NO/SPST-NC)

Item	Emergency Stop Switches	
	Push-lock turn-reset system	
	A22E, A22EL	
Total travel force (TTF) max.	44.1 N	
Total travel (TT)	10±1 mm	
Releasing force (RF) min.	0.25 N·m max. (See note.)	

**Note:** Rotation torque for Emergency Stop Pushbutton.

Nomenclature

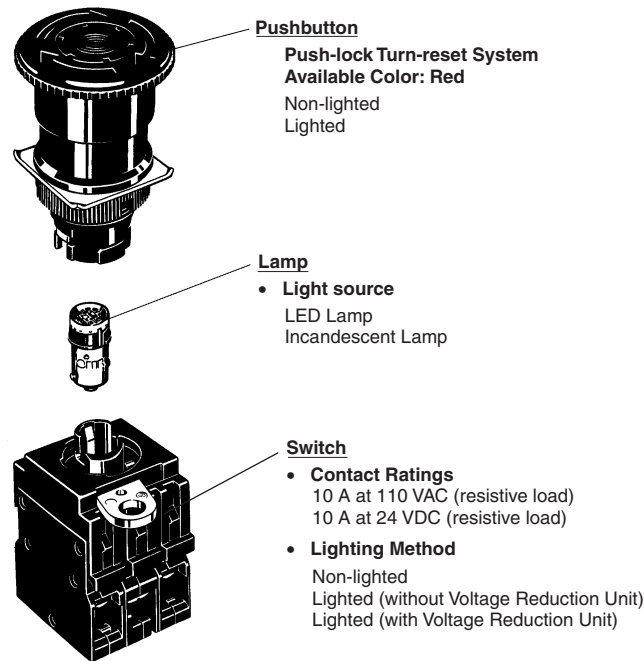

(The above figures are examples of the lighted model.)

Safety Lock Mechanism to Prevent Misuse

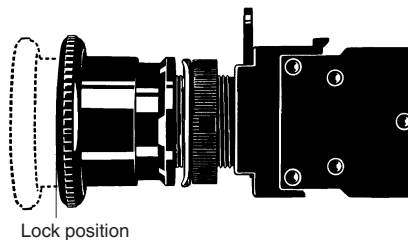

This Switch can be intentionally used to stop equipment in an emergency. Even if an object or person touches the Pushbutton by mistake, the contact will not be released unless the Pushbutton reaches the lock position.

**This Switch uses a finger protection mechanism to prevent electrical shocks. Moreover, it is provided with a mechanism to prevent terminal screws from coming off and also allows connection to either round or forked crimp terminals.**

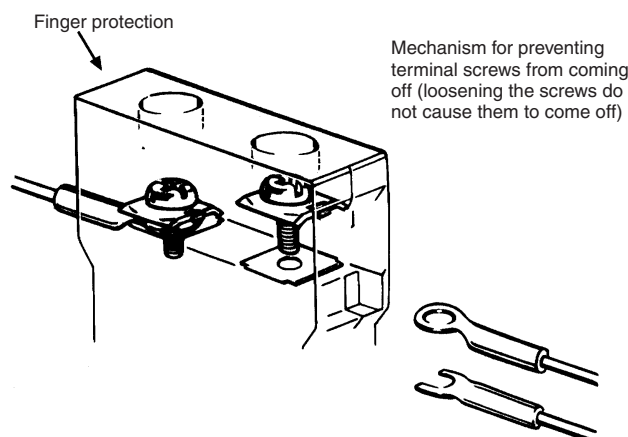

Dimensions

Note: All units are in millimeters unless otherwise indicated.

**A22E-MP**

Non-lighted models  
40-dia. Push-pull

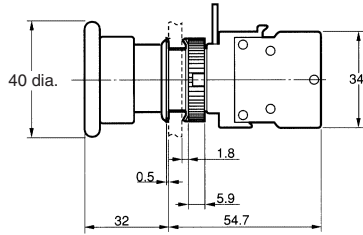
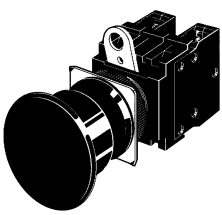

**A22E-LP**

Non-lighted models  
60-dia. Push-pull

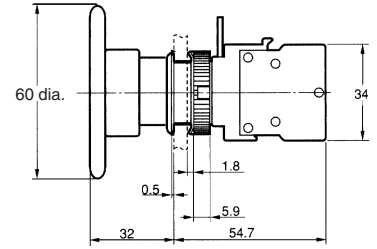
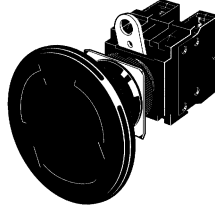

**A22E-S**

Non-lighted models  
30-dia. Push-lock, Turn-reset

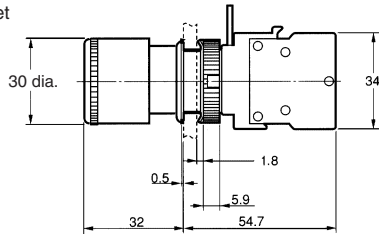
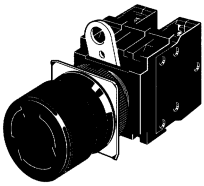

**A22E-M**

Non-lighted models  
40-dia. Push-lock, Turn-reset

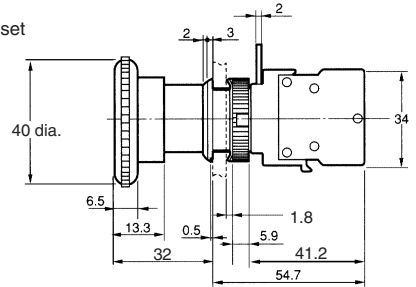
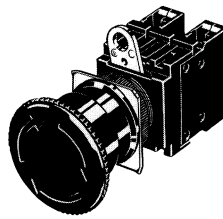

**A22E-L**

Non-lighted models  
60-dia. Push-lock, Turn-reset

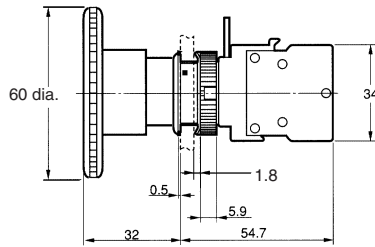
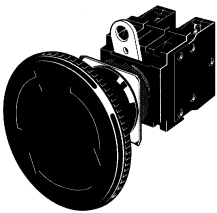

**A22E-SK**

Non-lighted models  
30-dia. Push-lock, Key-reset

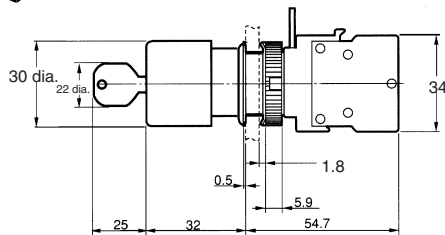
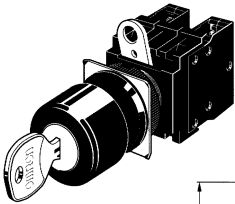

**A22E-MK**

Non-lighted models  
40-dia. Push-lock, Key-reset

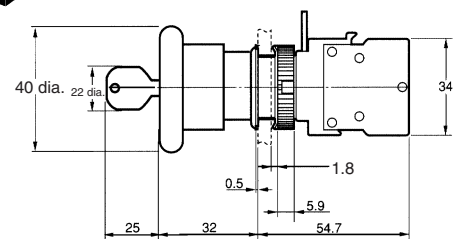
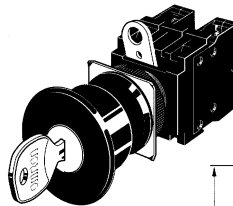

**A22EL-M**

Lighted models  
40-dia. Push-lock, Turn-reset

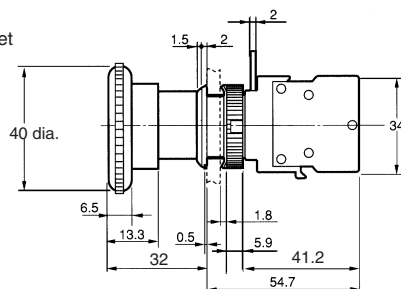
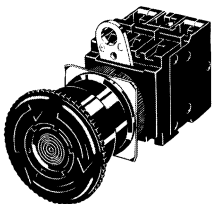

Dimensions for Accessories

Legend Plates For Emergency-stop

A22Z-3466-1

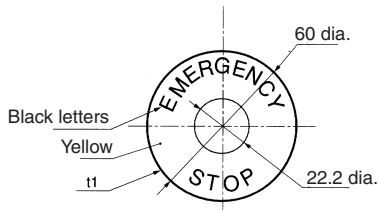

A22Z-3476-1

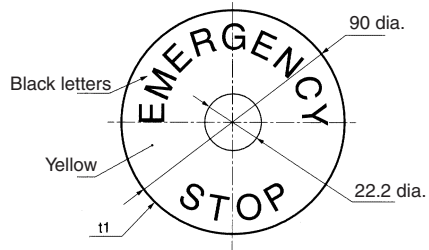

Lamp Extractor  
A22Z-3901

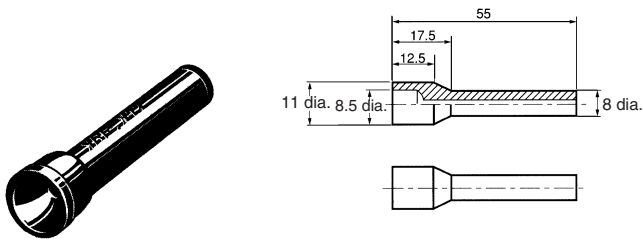

Tightening Wrench  
A22Z-3905

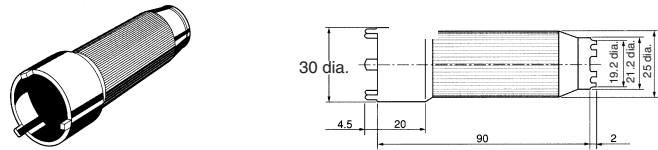

Lock Ring  
A22Z-3360

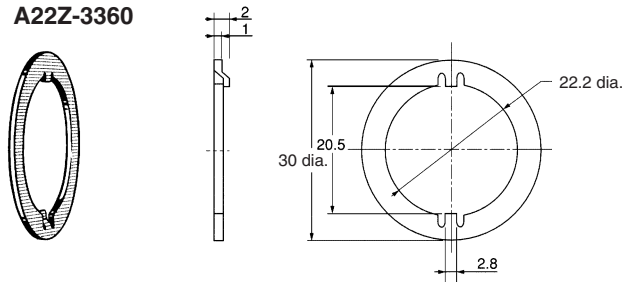

25-dia. Ring  
A22Z-R25

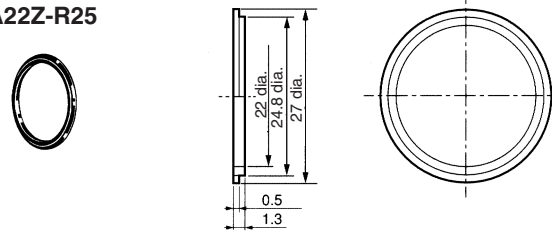

Lock Plate  
A22Z-3380

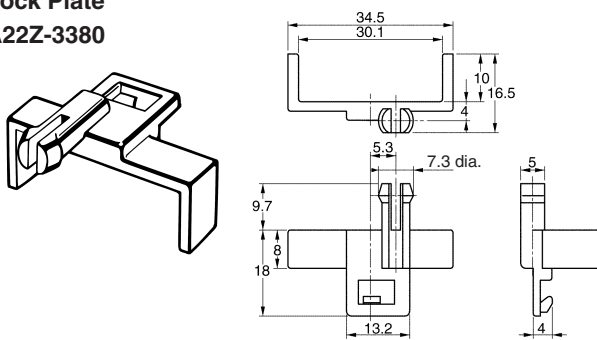

Control Box (Enclosure)

A22Z-B10□

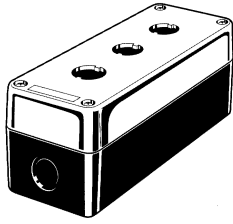

A22Z-B101 (One Hole)  
A22Z-B101Y

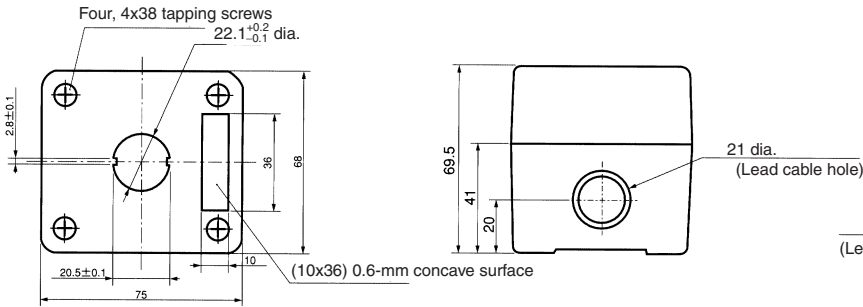

Cable Port Hole (Top View)

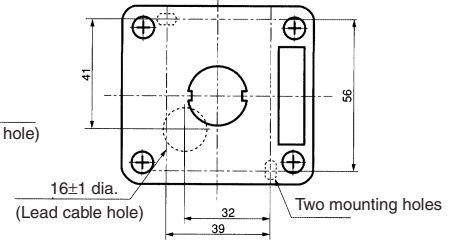

A22Z-B102 (Two Holes)

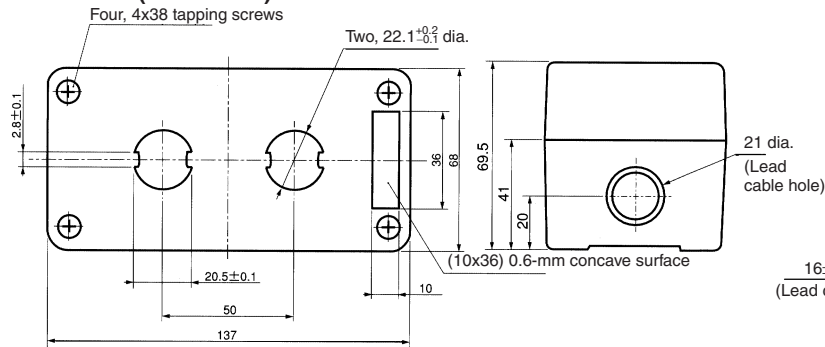

Cable Port Hole (Top View)

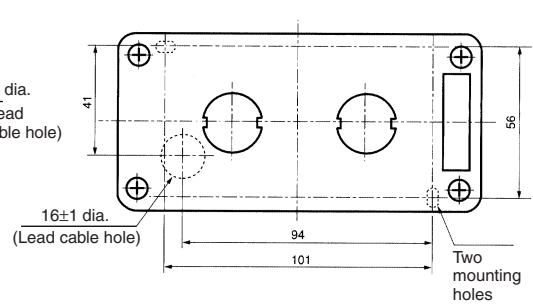

A22Z-B103 (Three Holes)

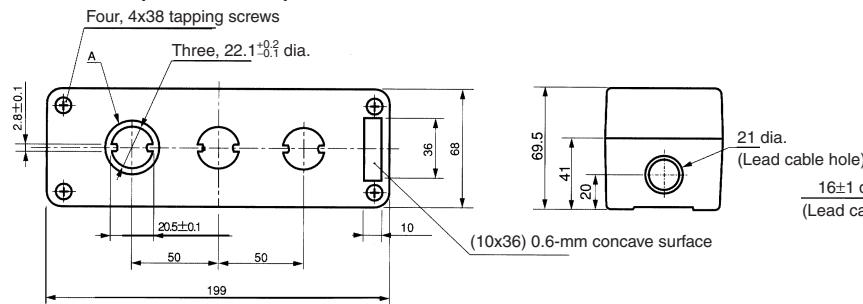

Cable Port Hole (Top View)

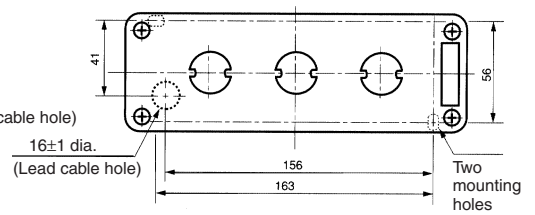

Panel Mounting Hole

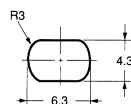

## Terminal Arrangement

### Terminal Arrangement (Bottom View)

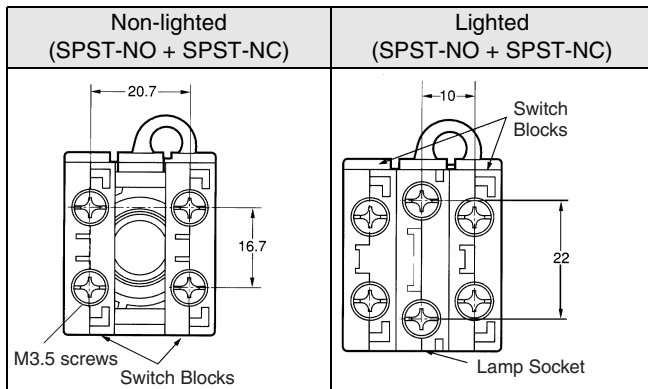

### Terminal Connection

Type	Terminal connection
Non-lighted	<p><b>Bottom view</b></p>
Lighted without Voltage Reduction Unit	<p><b>Bottom view</b></p>
Lighted with Voltage Reduction Unit	<p><b>Bottom view</b></p>

Note: The above terminal connection diagrams are examples for SPST-NO + SPST-NC.

### Panel Cutouts

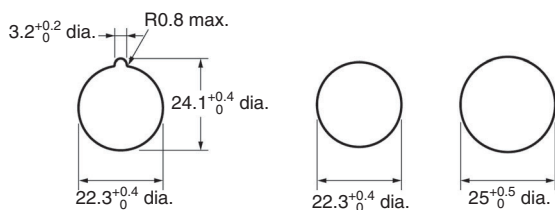

**With Lock Fitting**

**Without Lock Fitting**

- Note:**
1. When applying coating such as paint to the panel, the dimensions should be those after the application of coating.
  2. Recommended panel thickness: 1 to 5 mm.
  3. Use an A22Z-R25 Ring when mounting to a panel with 25-mm holes.

## Installation

### Mounting to the Panel

#### Mounting the Operation Unit on the Panel

Insert the Operation Unit (Pushbutton, etc.) from the front surface of the panel, insert the Lock Ring and the mounting nut from the terminal side, then tighten the nut. Before tightening, check that the rubber washer is present between the Pushbutton Unit and the panel.

When using a Legend Plate Frame, put one rubber washer each between the Legend Plate Frame and the panel and between the Operation Unit and the Legend Plate Frame. (One rubber washer will be provided when one Legend Plate Frame is ordered.)

Align the Lock Ring with the groove in the casing, then insert the Lock Ring so that its edge is located on the panel side.

Tighten the mounting nut at a torque of 0.98 to 1.96 N·m.

When using a Lock Ring, replace with the supplied Lock Ring, insert the projecting part into the lock slot, and then tighten the mounting nut.

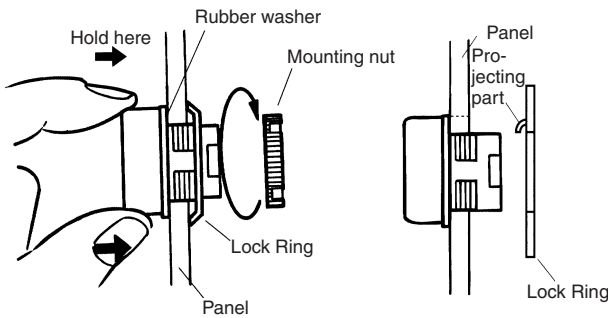

When the panel cutout dimension is 25 dia., remove the supplied rubber washer and mount the 25-dia. Ring as shown below. (Since the A22Z-R25 is not attached to the main body, order separately.)

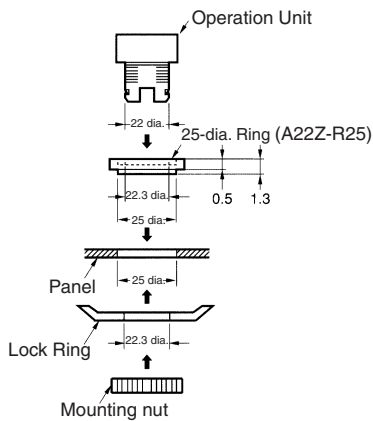

#### Mounting the Switch on the Pushbutton Unit

Insert the Pushbutton Unit into the Switch Unit, aligning the arrow mark inscribed on the Case with the lever on the Switch Blocks, then move the lever in the direction indicated by the arrow in the following figure.

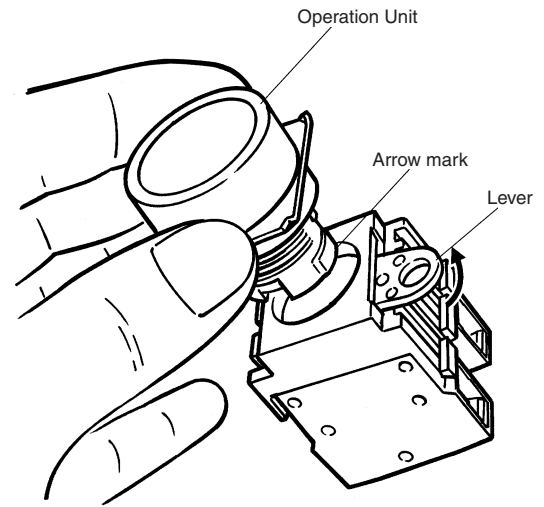

#### Removing the Switch

Move the lever in the direction indicated by the arrow in the following figure, then pull the Pushbutton Unit or the Switch Blocks.

Since the lever has a hole with an inside diameter of 6.5 mm, the lever can be moved in the specified direction by inserting a screwdriver into the hole and then moving the screwdriver.

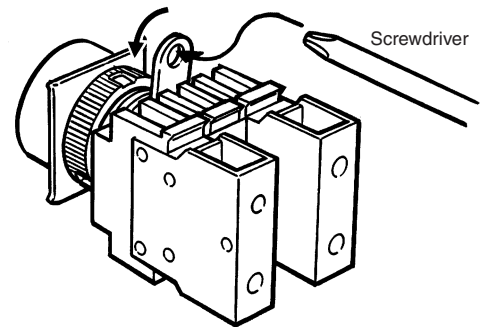

**Assembling the Cap**  
**Emergency Stop Switch**

Insert the protrusion of the Tightening Wrench (A22Z-3905) into the Cap slot and then turn to remove the Cap.

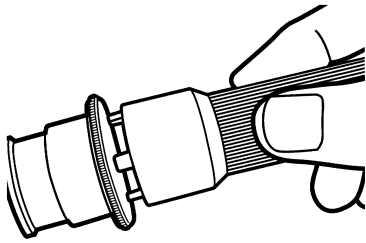

**Installing/Replacing the Lamp**  
**Installing/Replacing from the Panel Surface**

Insert the Lamp Extractor (A22Z-3901) into the lamp, then rotate the Extractor while pressing it.

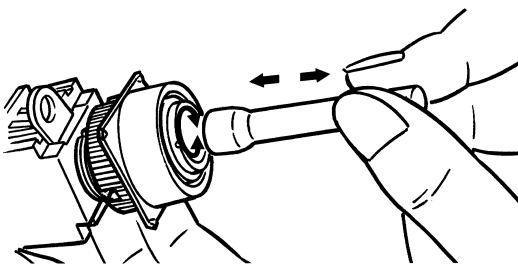

**Installing/Replacing on the Switch**

Grip the indicator with your fingers, then rotate the indicator while pressing it against the Switch.

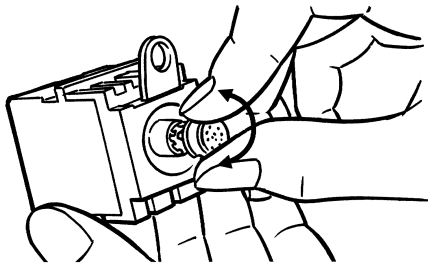

**Control Box (Enclosure)**  
**Mounting the Switch**

The Standard-size Legend Plate Frame can be mounted. Mount the Frame as shown in the following panel diagram. Mount the Switch in the same way as for an ordinary panel.

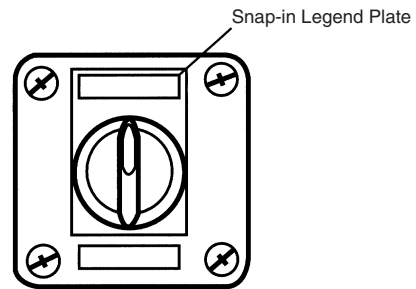

**Creating a Cable Port Hole**

Place the tip of a screwdriver on the surface where the cable port hole is to be created with the cover attached and strike the screwdriver to punch a hole. Attempts to punch a hole on the other side of the case will damage the Box.

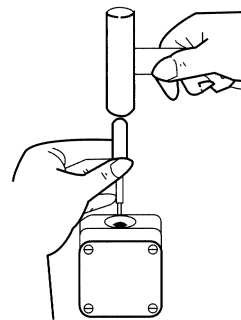

**Securing the Connector Cable**

1. Insert the connector into the cable port hole in the Box and secure with the fixing nut inside the box.
2. Open a hole in the thin rubber section of the rubber ring.
3. Pass the tightening cap through the cable, insert the cable into the connector, and tighten the hexagonal nut to secure the cable.

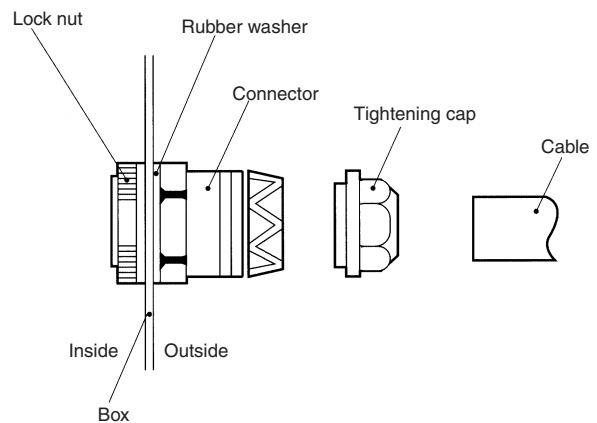

Cable diameter	Connector
7 to 9 dia.	A22Z-3500-1
9 to 11 dia.	A22Z-3500-2



## Installing/Removing the Switch Blocks

### Installing the Switch Blocks

Hook the small protrusion on the Mounting Latch into the groove on the other side of the lever, then push up the Switch Block in the direction indicated by the arrow in the figure below.

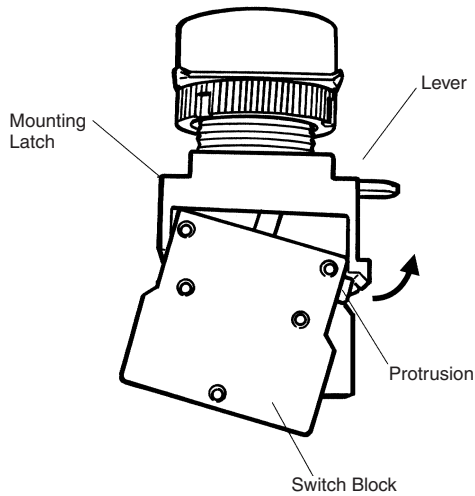

### Removing the Switch Blocks

Insert a screwdriver between the Mounting Latch and the Switch Block, then push down the screwdriver in the direction indicated by the arrow in the following figure.

Use either of the following screwdrivers.

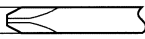
Flat-head screwdriver	3 to 6 mm	
Phillips screwdriver	3 to 6 mm	

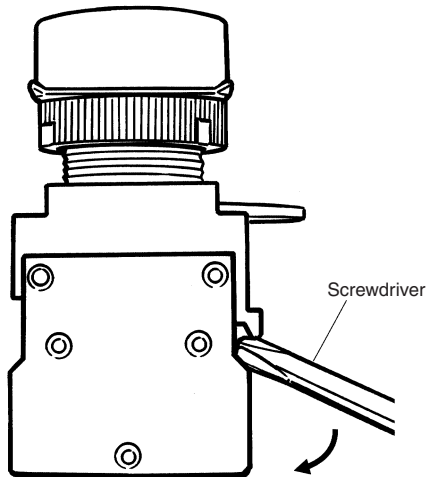

## Wiring

### Wiring Round Crimp Terminals

Loosen the terminal screw from the Switch Unit until it completely comes off the groove, insert a screwdriver as shown in the following figure, then push up the washer in the direction indicated by the arrow to temporarily secure it. Now, a round crimp terminal can be connected. After inserting the terminal, tighten the screws to complete wiring.

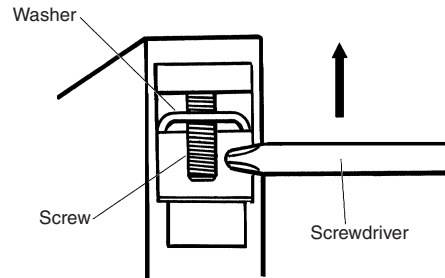

ALL DIMENSIONS SHOWN ARE IN MILLIMETERS.

To convert millimeters into inches, multiply by 0.03937. To convert grams into ounces, multiply by 0.03527.